



The Third Evolution™



Programmable,
RGB-backlit
LCD Keyswitches

SA3216 – SA3624 – SA6432



© 2006 copyright [E³] Engstler Elektronik Entwicklung GmbH. All rights reserved.

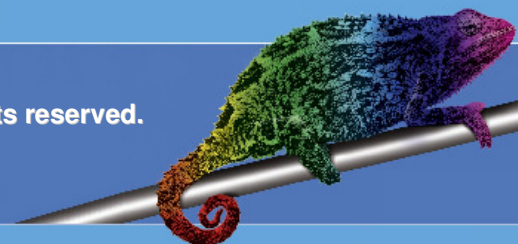

SA3216 – SA3624 – SA6432

Technical Datasheet



intentionally left blank



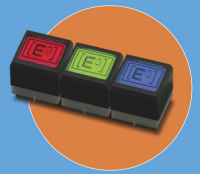
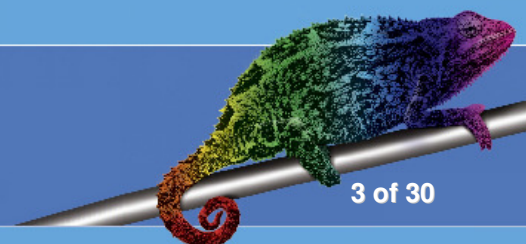

Table of Content

Table of Content	3
General Description	5
Innovative Product Features	5
Resolution	5
RGB Colors	5
Color Calibration.....	5
Self-Initialisation	5
Legacy Mode™	5
Low Power Consumption.....	5
Technical Overview.....	6
SA3216 – SA3624 – SA6432	7
Dimensions	7
Keypad	7
Layout	8
Drill Masks.....	8
Mounting Methods.....	9
Liquid Crystal Display	10
Environmental Specifications.....	11
Electrical Specifications.....	11
Interfacing SA3216 - SA3624 - SA6432.....	12
Contact Terminals	12
Block Diagram	13
Serial Protocols	14
Legacy Mode™ (SA3216 and SA3624 only!).....	14
Advanced Technology™ Mode	15
Timing Diagram	15
Command Set	16
Synchronous Protocol.....	16
Command and Data Formats.....	16
Commands	17



SA3216 – SA3624 – SA6432

Technical Datasheet



Command Examples.....	19
Bit / Pixel Mapping	21
Color Table	24
Controlling SA Switch Arrays	25
Order Information.....	26
Change History	27
Notices.....	28
Copyright Notice.....	28
Technical Notices.....	28
Life Support Applications.....	28
Flammability Ratings	28
Warranty Disclaimer	29
Contact Information.....	30

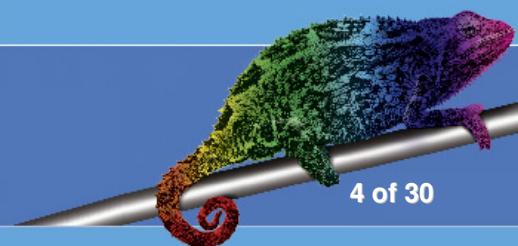

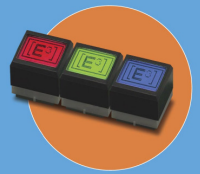

General Description

The SA switch family includes the SA3216, SA3624 and SA6432 LCD Keyswitches with command driven serial interfaces. They integrate a graphical liquid crystal display with **RGB** backlighting in a keyswitch. The SA keys are controlled via a serial interface to the integrated *Advanced Technology*[™] electronics, which control the interface, display and backlighting. SA keys self-initialise without external setup commands. Data is only needs to be transmitted when a change is made to the display or background colors. Only six contact terminals are needed to provide power, clock and data lines as well as switch contacts. The contact pins of the internal switch are isolated from the internal electronics.

Innovative Product Features

Resolution

Three different resolutions available:

SA3216	32x16 pixels
SA3624	36x24 pixels
SA6432	64x32 pixels

RGB Colors

SA3216, **SA3624** and **SA6432** keys support 64 **RGB** colors.

Color Calibration

No color sorting due to *Advanced Technology*[™] electronics. The **RGB** backlighting of all keyswitches is calibrated for maximum uniformity.

Self-Initialisation

All keys self-initialise. No external setup commands required.

Legacy Mode[™]

Backward compatibility for use in legacy systems.

Low Power Consumption

Less than 60mA maximum current is needed when bright white backlighting is selected. Typical value is less than 25mA with one of the **RGB** colors.

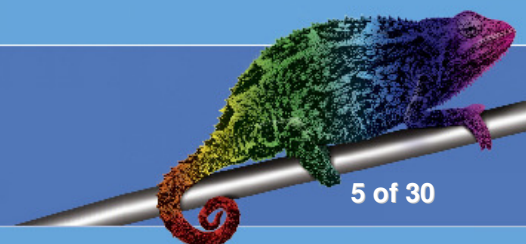

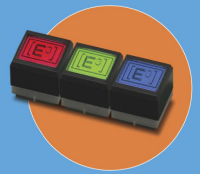

Technical Overview

Features	SA3216	SA3624	SA6432
Resolution	32 x 16	36 x 24	64 x 32
RGB backlight colors	Over 10,000 RGB colors		
Interfaces	Synchronous serial 8-bit interfaces (custom protocols available upon request)		
	Legacy Mode™ Synchronous serial 12-bit interface		
External clock	Required; 60 kHz up to 2 MHz		No external clock required
Extended Environmental Specifications	Upon request		Hardened MIL- Spec version available (requires custom control panel development)
Self-initialisation	Yes		
Maximum speed	2 MBaud		
Operating supply	4.9 V to 5.1 V		
Keyswitch type	tactile, 2.0 mm travel with over travel protection		
Keyswitch life time	> 3.0 million cycles		
Contact resistance	< 200 Ohm		
Operating temperature	0 °C to 55 °C		
Storage temperature	-30 °C to 70 °C		

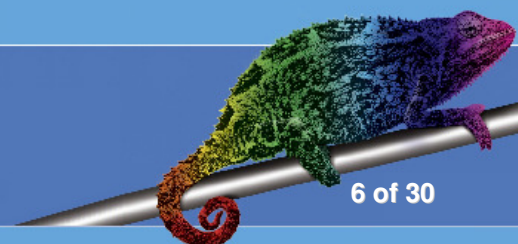

SA3216 – SA3624 – SA6432

Technical Datasheet

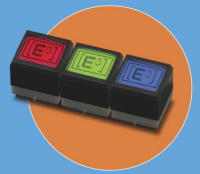

SA3216 – SA3624 – SA6432

Dimensions

Dimensions (X x Y x Z)
Screen size (X x Y)

24.5 x 23.5 x 26.0 mm + / - 0,2 mm
20.0 x 16.5 mm + / - 0.1 mm

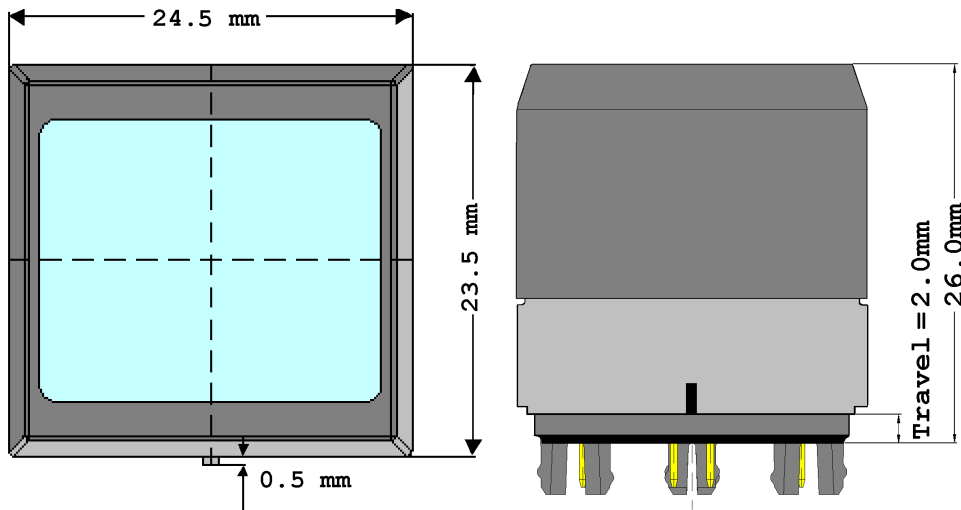

Keyswitch

Key stroke: 2.0 mm +/- 0.1 mm; tactile
Operation force: 1.3 N +/- 0.2 N
Over travel protection: yes
Lifetime: > 3 million cycles

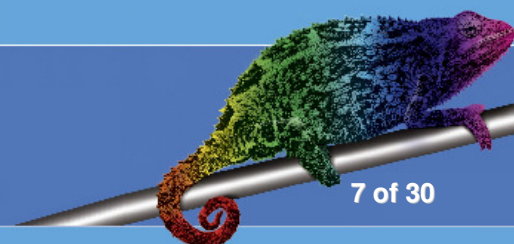
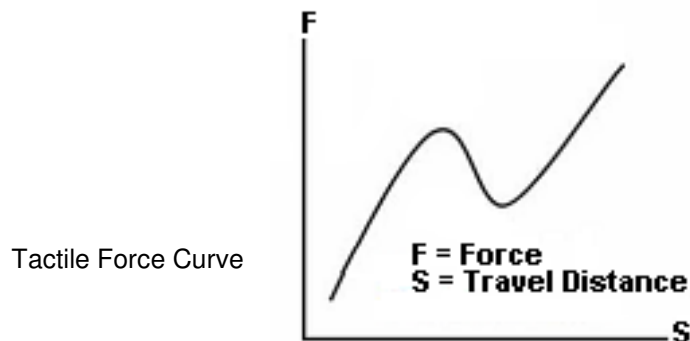



Layout

**Direct PCB Mount
(top view)**

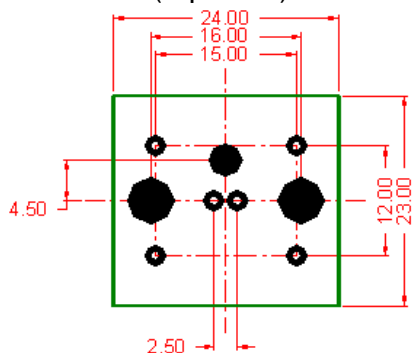

ALL DIMENSIONS IN mm
ALL DIMENSIONS ± 0.10 mm
ALL HOLE SIZES $+0.10/0.00$ mm

- $\varnothing 1.00$ PTH HOLE x $\varnothing 2.00$ PADS
- $\varnothing 3.50$ HOLE
- $\varnothing 5.10$ HOLE

**Socket Mount
(top view)**

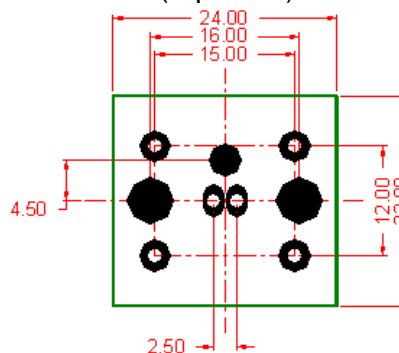

- $\varnothing 1.60$ PTH HOLE x $\varnothing 2.00 \times 3.20$ PADS
- $\varnothing 1.60$ PTH HOLE x $\varnothing 3.20$ PADS
- $\varnothing 3.50$ HOLE
- $\varnothing 5.10$ HOLE

Drill Masks

**for direct soldering
(top view)**

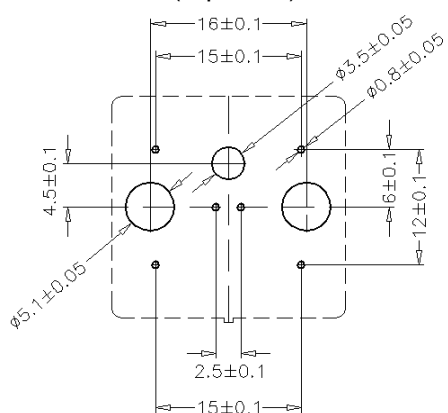

**for use with socket pins
(top view)**

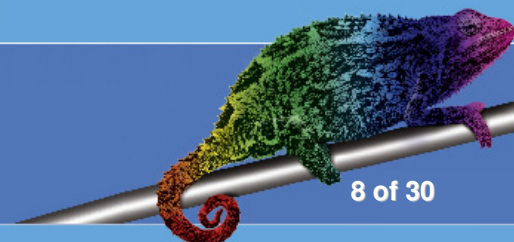
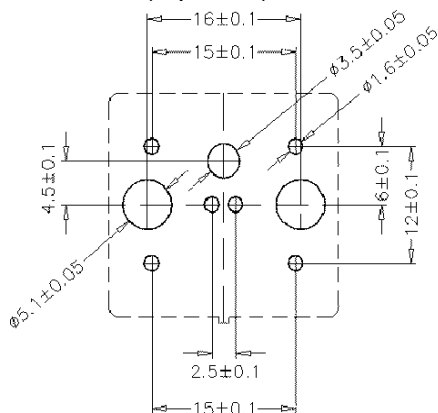

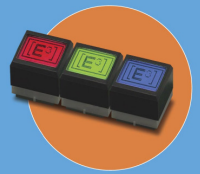

Recommended distance for array assembly is 1mm between each key.

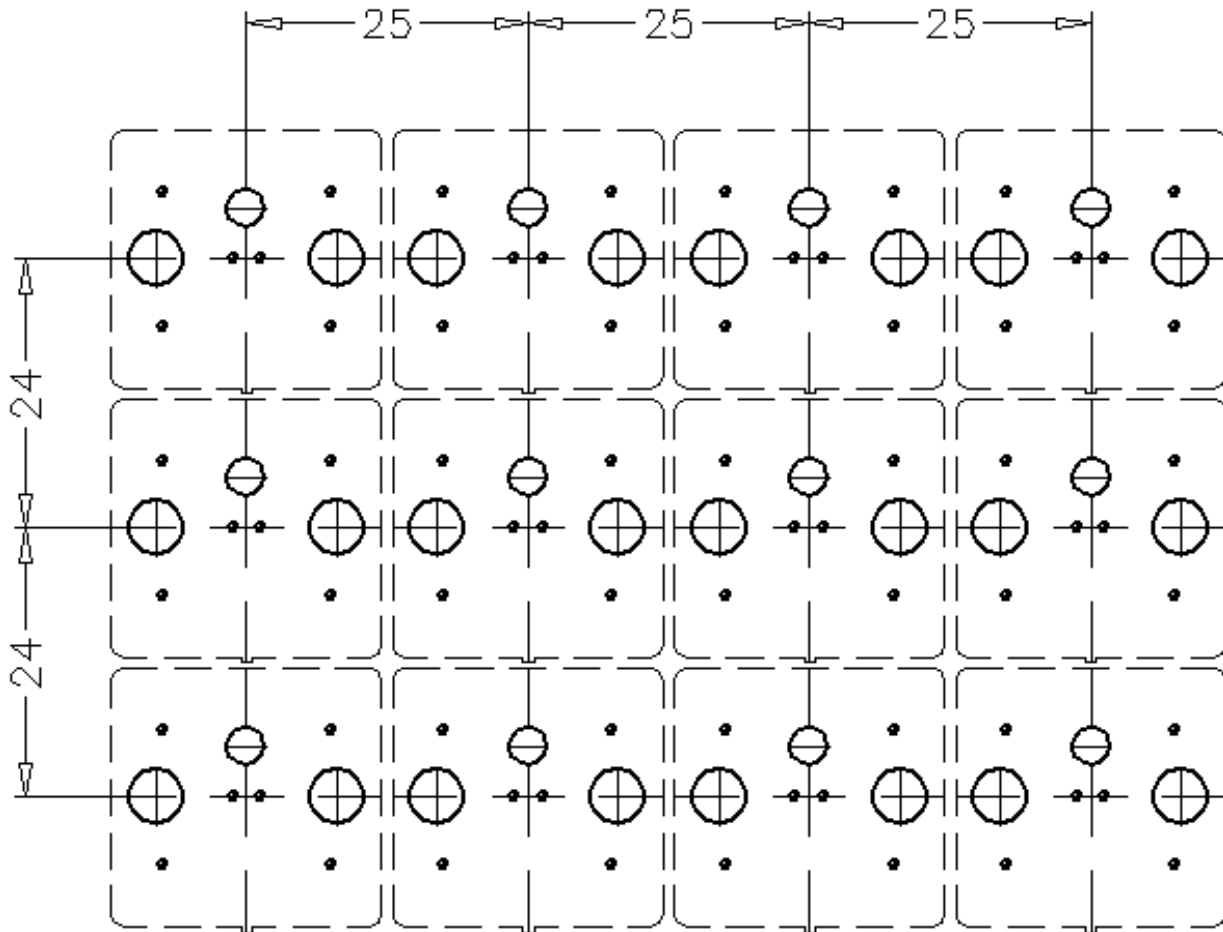

Mounting Methods

Socket mountable (see corresponding Drill Mask). Socket pins (**SP0000**) and socket locks (**SL0000**) are used for field-exchangeable mounting.

Through-hole mountable on PCBs with x, y, z mm thickness

Manual soldering: max. 350° C for max. 3.5 seconds per pin

Wave soldering: 260° C for 10 seconds

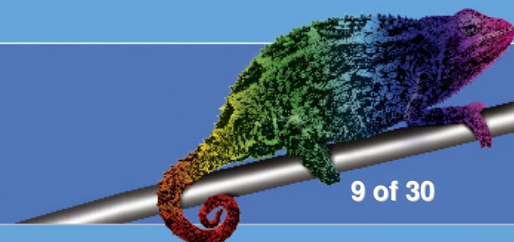

SA3216 – SA3624 – SA6432

Technical Datasheet



Liquid Crystal Display

Screen Size (X x Y)

17.26 mm x 12.14 mm

Pixel Size (X x Y) **SA3216** 0.52 mm x 0.74 mm
 SA3624 0.46 mm x 0.48 mm
 SA6432 0.25 mm x 0.36 mm

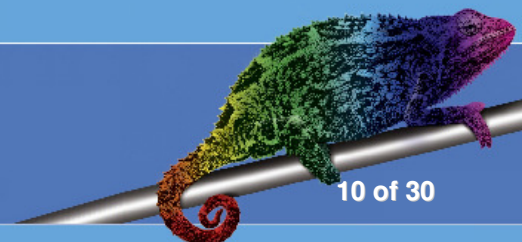
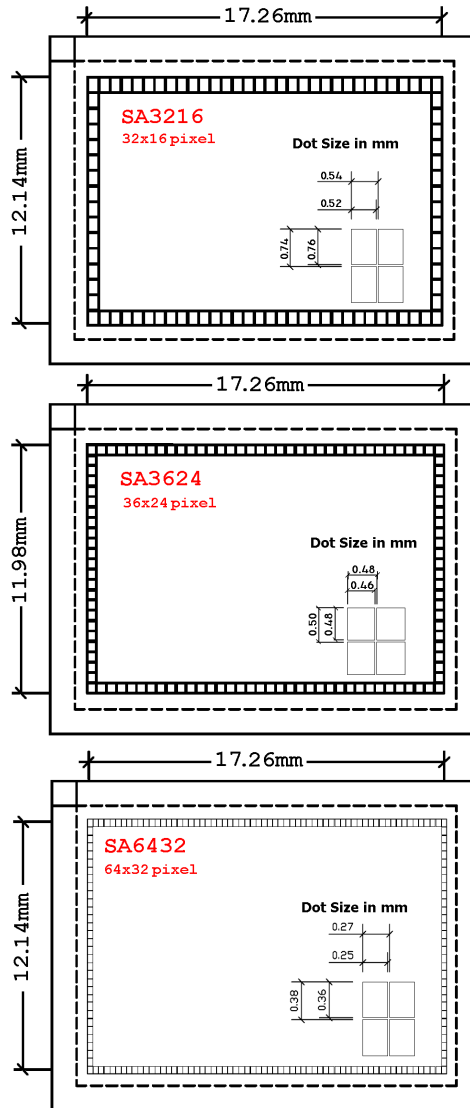



Environmental Specifications

Operating temperature	0 °C to 55 °C
Storage temperature	-30 °C to 70 °C
Humidity	up to 75% relative humidity at 70 °C

Electrical Specifications

Operating voltage	4.9 V to 5.1 V
Current consumption	max. 60 mA; typ. < 30 mA; min. 8 mA
Contact resistance	< 200 Ohm
Insulating resistance	> 100 MOhm

Symbol	Parameter	Min.	Typ.	Max.	Unit
$V_{DD}^{*1)}$	Operating voltage	4.9		5.1	V
$I_{DD}^{*2)}$	Supply current	8	<20	60	mA
V_{IN}	Input voltage on any pin			$V_{SS} - 0.3 - V_{DD} + 0.3$	V
I_{DIO}	Output data current sunk/source			+/- 5	mA
I_{CIO}	Output clock current sunk/source			+/- 5	mA
V_{IL}	Input low level voltage	$V_{SS} - 0.3$		$0.3 \times V_{DD}$	V
V_{IH}	Input high level voltage	$0.7 \times V_{DD}$		$V_{DD} + 0.3$	V
C_{CIO}	I/O clock pin capacitance		10		pF
$C_{DIO}^{*3)}$	I/O data pin capacitance		230		pF

*1) Voltage range to ensure proper display contrast restricted to 4.9V to 5.1V

*2) Special power saving models available on request

*3) The I/O data pin capacitance will be reduce in future products without notice.

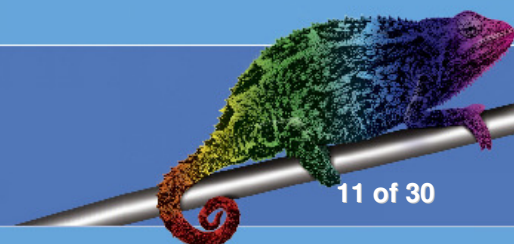



Interfacing SA326 - SA3624 - SA6432

Contact Terminals

Pin	Symbol	Description	Comment
1	GND	negative (ground) power terminal	0.0 V
2	+ 5V	positive power terminal	+4.9 V – +5.1 V
3	CLOCK	clock line to synchronize data write and for internal use	60 kHz – 2 MHz
4	DATA	command and data line to internal <i>Advanced Technology™</i> electronics	HIGH when inactive; see data format for details
5	SW1	switch contact	contact resistance < 200 Ohm
6	SW2	switch contact	contact resistance < 200 Ohm

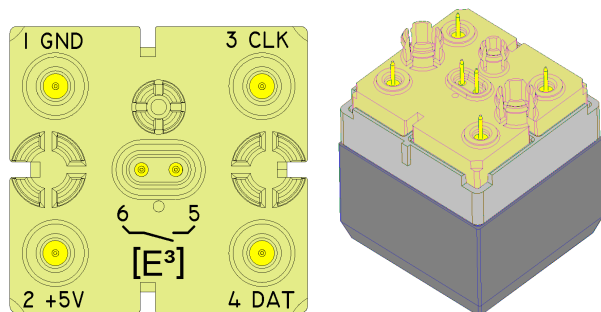

Pin View (terminal name and number are also marked on the keyswitch)

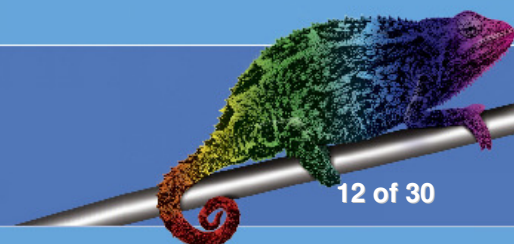



Block Diagram

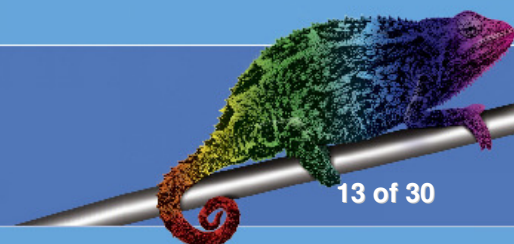
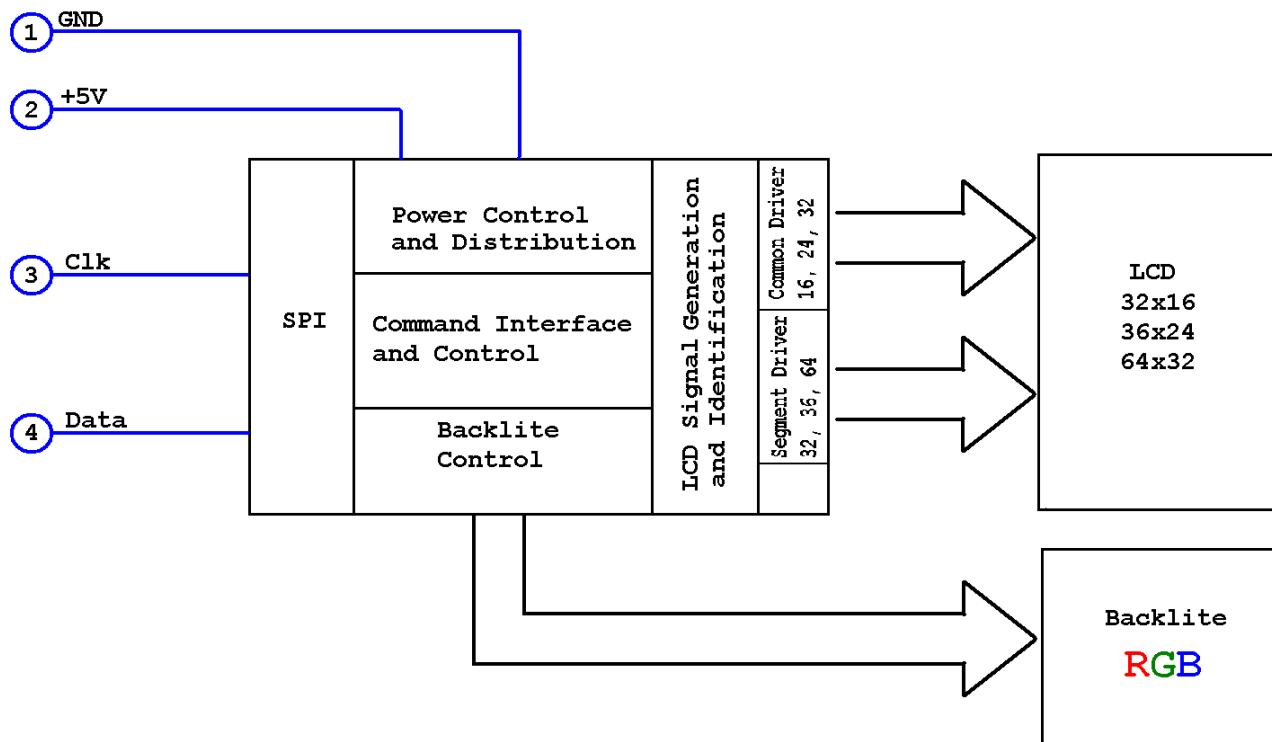



Serial Protocols

The SA3216, SA3624 and SA6432 keyswitches are connected to the controlling central processing unit by a 2 wire serial connection.

Currently, the SA switches support **two different** protocols:

Legacy Mode™ (SA3216 and SA3624 only!)

Advanced Technology™ Mode

Additional protocols are available upon request. Please contact your local [E³] distributor or [E³] directly at techsupport@e3-keys.com.

Feature	Legacy Mode™	Advanced Technology™ Mode
Clock Frequency	64 kHz to 2 MHz	up to 2 MHz
Permanent Clock	Yes	No
Data Word Size	12 bit	8 bit
Internal Serial Number	No	Yes*
Internal Failure Detection	No	Yes*

* To take advantage of these advanced functions your hardware must ensure that the SA keys are actively driving the serial data lines in **Advanced Technology™** mode.

LEGACY MODE™ (SA3216 AND SA3624 ONLY!)

Legacy Mode™ applies only to the use of SA3216 and SA3624 keyswitches in legacy systems. This mode is supported in order to ease the transition to the new possibilities of the SA switches in existing hardware environments. The intelligent electronics of the SA switches detect the existing protocol and automatically convert the data into the data stream that is required for SA switches. In order to make a system compatible with the **Legacy Mode™** it may be necessary to adjust the clock frequency and/or to increase the transfer bit count per data word.

If you have questions regarding the implementation of **Legacy Mode™**, please contact your local [E³] distributor or [E³]’s R&D department directly at techsupport@e3-keys.com.

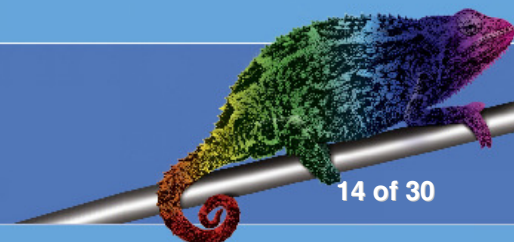

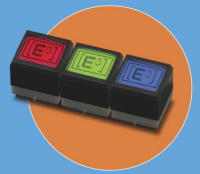

ADVANCED TECHNOLOGY™ MODE

This is the standard mode for controlling SA keyswitches and provides full access to all capabilities of the SA3216, SA3624 and SA6432 keys. The details of this control protocol are documented in the subsequent paragraphs

The **Advanced Technology™** Mode uses a conventional synchronous protocol. A permanently applied clock is not necessary.

The only difference to a true 8-bit synchronous data transmission is that the data may also be synchronized to a permanently applied clock. No parity checking/generation is required.

Since it is possible that the clock is applied permanently a StartBit is required to be able to detect the start of a transmission. To allow for a StartBit in a standard synchronous SPI the MSB of the DataByte is to be set to 0.

Note: Customer-specific protocols are possible. Future versions will include other types of interfaces such as I²C bus and asynchronous protocols

TIMING DIAGRAM

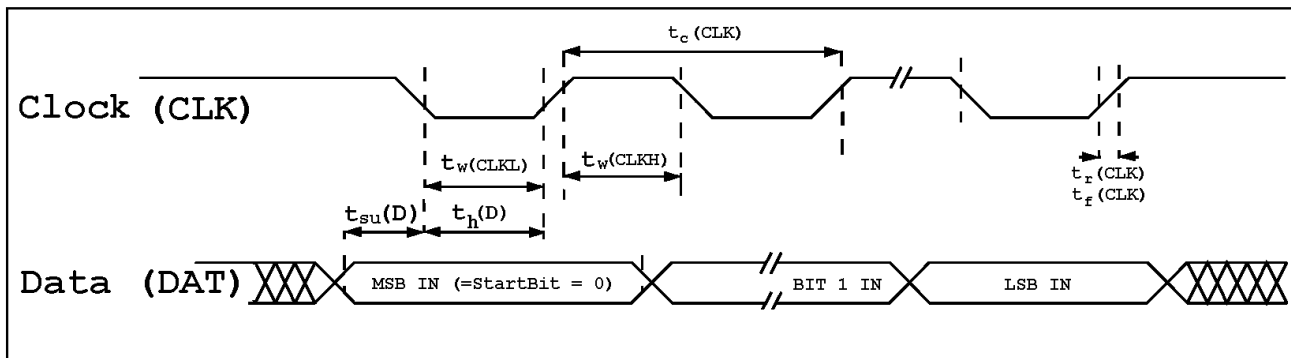

Symbol	Parameter	Min	Max	Unit
$t_c(\text{CLK})$	SPI Clock frequency	0.06	2	MHz
$t_w(\text{CLKH})$	Clock high time	90		ns
$t_w(\text{CLKL})$	Clock low time	90		ns
$t_{su}(\text{D})$	Data input setup time	140		ns
$t_h(\text{D})$	Data input hold time	100		ns
$t_r(\text{CLK})$	Clock rise time	15		ns
$t_f(\text{CLK})$	Clock fall time	15		ns

Note: In order to ensure proper synchronization to the data, if there is a permanently applied clock, the command and data bytes should follow each other either without a gap or with a gap of more than 8 clock cycles.

The time between data bytes may not exceed 1ms or the protocol will terminate current command.

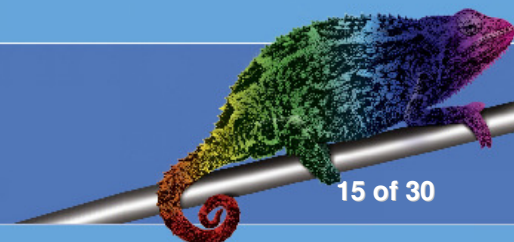

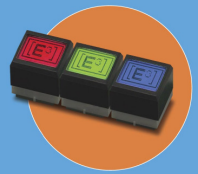

Command Set

SYNCHRONOUS PROTOCOL

The command structure is quite simple as you can see in the following table. Due to the possibility of a permanently applied clock each transmitted data must have a leading “0”. To distinguish between command and data the sixth bit is reserved. There are three sets of commands:

Write Data to the LCD Display

Set Backlight Color

Extended Command Set

The first two command sets imply the required data and do not expect a return value from the key. Some commands in the Extended Command set, however, request information to be returned by the key. In this case, the Advanced Technology™ electronics will generate their own clock signal for the data transmission. For details on this scenario, see the **Applications Notes** on our website www.e3-keys.com.

Note: If you are running the keys in a *Legacy Mode*™ environment you cannot use the extended commands since legacy systems do not support returning information from the keys. This may cause a hardware collision, which may result in damage to your system.

COMMAND AND DATA FORMATS

<i>Command (binary representation)</i>	<i>Command Name / Description</i>	<i>Comments</i>
01xxxxxx	Command format	“xxxxxx” contains command values according to the Commands table on page 15.
00xxxxxx	Data format	Data to be sent to the key must always have bit 6 reset. Note: All commands and data will have bit 7 reset in order to make the protocol compatible with systems having a permanently applied clock.

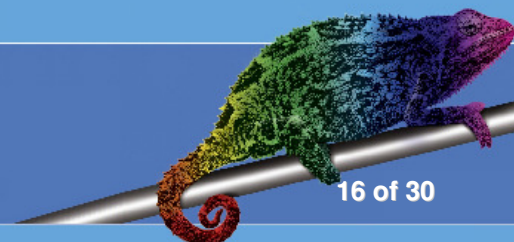

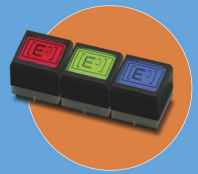

COMMANDS

<i>Command (binary representation)</i>	<i>Command Name / Description</i>	<i>Comments</i>
01000000 (0x40)	Set Display Address & Write Display Data	<p>All writes to the display must be initiated by this command. Address pointer is auto-incremented by data transmission.</p> <p>The command expects min. 4 data words to follow: 0000000A₈ 0000A₇A₆A₅A₄ 0000A₃A₂A₁A₀ 0000D₃D₂D₁D₀</p> <p>Multiple Data Bytes may follow without additional addressing in one sequence since the controller will perform auto-increment</p> <p>Details are found in the Bit/Pixel Mapping tables on pages 18-20.</p>
01000001 (0x41)	Set Color	<p>There is one data word to follow: 00R₁R₀G₁G₀B₁B₀</p> <p>Details are found in the Color table on page 21.</p>
01000010 (0x42)	Set RGB Color	<p>There are 3 data bytes to follow: 0D₆D₅D₄D₃D₂D₁D₀ 0D₆D₅D₄D₃D₂D₁D₀ 0D₆D₅D₄D₃D₂D₁D₀</p> <p>Note: The lower 10 values on each color brightness value should only be used for single color applications due to restrictions in the color calibration.</p> <p>These colors may change and should be used with caution until otherwise noted by [E³]</p>
01000011 (0x43)	End Transmission	<p>Ends data transmission to keys and awaits next command sequence. Transmitted commands are begin processed and displayed.</p> <p>This command should be placed at the end of a sequence.</p>

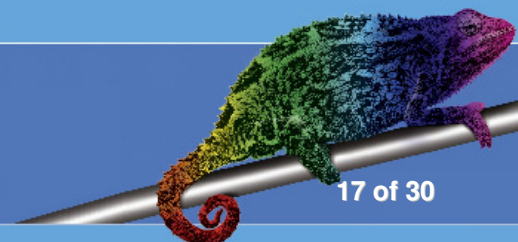

SA3216 – SA3624 – SA6432

Technical Datasheet

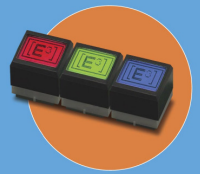

01000100 (0x44)	Read Keyswitch ID THIS COMMAND FORCES THE KEYSWITCH TO ANSWER ON THE CLOCK AND DATA LINE. (The clock is generated by the SA switch; see Application Notes at www.e3-keys.com)	The answer is consisting of ASCII characters representing the Keyswitch ID and is terminated with CR (0x0D): SA3216 SA3624 SA6432 (not supported in <i>Legacy Mode™</i>)
01000101 (0x45)	Read Serial Number THIS COMMAND FORCES THE KEYSWITCH TO ANSWER ON THE CLOCK AND DATA LINE. (The clock is generated by the SA switch; see Application Notes at www.e3-keys.com)	The answer is consisting of 4 Bytes which give the serial Number in the following format and is terminated with CR (0x0D): SNYYWW##### Year (04-99) Week (01-52) Number (00000 .. 99999) (not supported in <i>Legacy Mode™</i>)

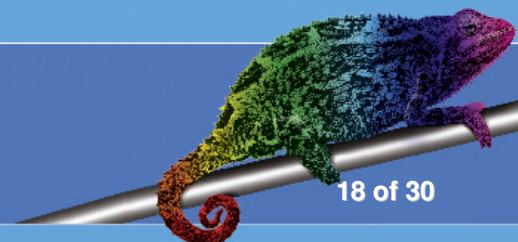

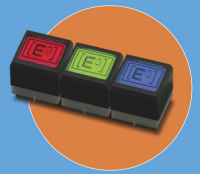

COMMAND EXAMPLES

Set display address to point to upper right corner of display:

01000000 00000000 00000000 00000000 (0x40 0x00 0x00 0x00)

Write Data to Display

Binary	HEX	Comments
01000000	0x40	Set display address & Write to Display
00000000	0x00	Data: 00000 for A₈
00000000	0x00	Data: 00000 for A₇A₆A₅A₄
00000000	0x00	Data: 00000 for A₃A₂A₁A₀
00000101	0x05	Write pattern 0101 to LCD Display and increment address by 1
00000101	0x05	Write pattern 0101 to LCD Display and increment address by 1
00000101	0x05	Write pattern 0101 to LCD Display and increment address by 1
00000101	0x05	Write pattern 0101 to LCD Display and increment address by 1

Set backlighting color to light orange:

01000001 00111000 (0x41 0x38)

Binary	HEX	Comments
01000001	0x41	Set color
00111000	0x38	Red : high intensity, Green medium intensity, Blue off

The 2 individual bits for each color intensity have the following structure:

00 = off
 01 = low
 10 = medium
 11 = high

End transmission and process data:

01000011 (0x43)

Binary	HEX	Comments
01000011	0x43	End transmission

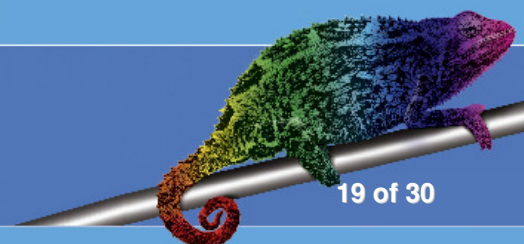

SA3216 – SA3624 – SA6432

Technical Datasheet

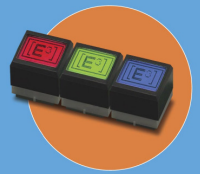

Read Keyswitch ID:

01001000 (0x48)

Binary	HEX	Comments
01001000	0x48	Read Keyswitch ID

The Key will answer by generating its own clock and data signals (see **Application Notes** at www.e3-keys.com for details)

The following examples show the answers for the different SAxxxx types:

0x53 0x41 0x33 0x32 0x31 0x36 0x0D = SA3216 CR

0x53 0x41 0x33 0x36 0x32 0x34 0x0D = SA3624 CR

0x53 0x41 0x36 0x34 0x33 0x32 0x0D = SA6432 CR

Read Serial Number:

01001001 (0x49)

Binary	HEX	Comments
01001001	0x49	Read Serial Number (SNYYWW#####)

The Key will answer by generating its own clock and data signals (see **Application Notes** at www.e3-keys.com for details)

The following example shows the format of the answer:

0x53 0x4E 0x30 0x34 0x30 0x33 0x30 0x35 0x30 0x39 0x33 0x0D = SN040305093CR

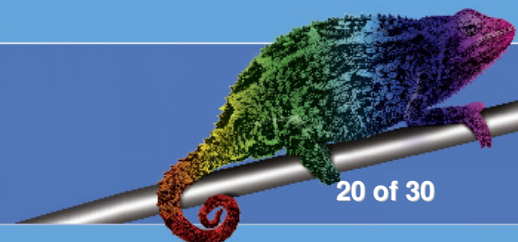

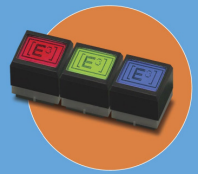

BIT / PIXEL MAPPING

Display Memory – Internal RAM Structure

The static display RAM holds the data for the LCD display. This data is displayed automatically and is continuously refreshed without further interference from the host controller.

The display RAM is organized into 512 x 4 bits and stores the display data in the SA switch. The content of the display RAM is mapped directly to the LCD display. This RAM can be accessed by the Write LCD Data command, which must be preceded by the Set LCD Address command. The SET LCD Address command tells the key where to write the data and where to display it on the LCD. For actual RAM-Display mapping please refer to the corresponding Bit/Pixel mapping tables below.

Bit/Pixel Mapping Table for SA3216

	Column 31	Column 30	Column 29	Column 28	...	Column 3	Column 2	Column 1	Column 0
Address	7CH	78H	74H	70H	...	0CH	08H	04H	00H
Row 0	D ₀	D ₀	D ₀	D ₀	...	D ₀	D ₀	D ₀	D ₀
Row 1	D ₁	D ₁	D ₁	D ₁	...	D ₁	D ₁	D ₁	D ₁
Row 2	D ₂	D ₂	D ₂	D ₂	...	D ₂	D ₂	D ₂	D ₂
Row 3	D ₃	D ₃	D ₃	D ₃	...	D ₃	D ₃	D ₃	D ₃
Address	7DH	79H	75H	71H	...	0DH	09H	05H	01H
Row 4	D ₀	D ₀	D ₀	D ₀	...	D ₀	D ₀	D ₀	D ₀
Row 5	D ₁	D ₁	D ₁	D ₁	...	D ₁	D ₁	D ₁	D ₁
Row 6	D ₂	D ₂	D ₂	D ₂	...	D ₂	D ₂	D ₂	D ₂
Row 7	D ₃	D ₃	D ₃	D ₃	...	D ₃	D ₃	D ₃	D ₃
Address	7EH	7AH	76H	72H	...	0EH	0AH	06H	02H
Row 8	D ₀	D ₀	D ₀	D ₀	...	D ₀	D ₀	D ₀	D ₀
Row 9	D ₁	D ₁	D ₁	D ₁	...	D ₁	D ₁	D ₁	D ₁
Row 10	D ₂	D ₂	D ₂	D ₂	...	D ₂	D ₂	D ₂	D ₂
Row 11	D ₃	D ₃	D ₃	D ₃	...	D ₃	D ₃	D ₃	D ₃
Address	7FH	7BH	77H	73H	...	0FH	0BH	07H	03H
Row 12	D ₀	D ₀	D ₀	D ₀	...	D ₀	D ₀	D ₀	D ₀
Row 13	D ₁	D ₁	D ₁	D ₁	...	D ₁	D ₁	D ₁	D ₁
Row 14	D ₂	D ₂	D ₂	D ₂	...	D ₂	D ₂	D ₂	D ₂
Row 15	D ₃	D ₃	D ₃	D ₃	...	D ₃	D ₃	D ₃	D ₃

Note:

The display can also be inscribed by using 0x0f as data in the not available positions.

Example:

```
0x40 0x00 0x00
0x00 0xyy 0xzz
0xaa 0xbb 0x0f
0x0f 0xcc 0xdd
0xee 0xff
```

This has the same result as

```
0x40 0x00 0x00
0x00 0xyy 0xzz
0xaa 0xbb 0x40
0x00 0x00 0x06
0xcc 0xdd 0xee
0xff
```

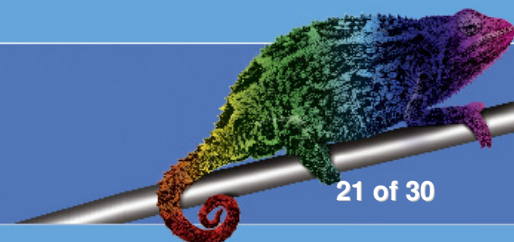

SA3216 – SA3624 – SA6432

Technical Datasheet

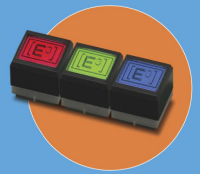

Bit/Pixel Mapping Table for SA3624

	Column 35	Column 34	Column 33	...	Column 3	Column 2	Column 1	Column 0
Address	11EH	116H	10EH	...	1EH	16H	0EH	06H
Row 16	D ₀	D ₀	D ₀	...	D ₀	D ₀	D ₀	D ₀
Row 17	D ₁	D ₁	D ₁	...	D ₁	D ₁	D ₁	D ₁
Row 18	D ₂	D ₂	D ₂	...	D ₂	D ₂	D ₂	D ₂
Row 19	D ₃	D ₃	D ₃	...	D ₃	D ₃	D ₃	D ₃
Address	11FH	117H	10FH	...	1FH	17H	0FH	07H
Row 20	D ₀	D ₀	D ₀	...	D ₀	D ₀	D ₀	D ₀
Row 21	D ₁	D ₁	D ₁	...	D ₁	D ₁	D ₁	D ₁
Row 22	D ₂	D ₂	D ₂	...	D ₂	D ₂	D ₂	D ₂
Row 23	D ₃	D ₃	D ₃	...	D ₃	D ₃	D ₃	D ₃
Address	118H	110H	108H	...	18H	10H	08H	00H
Row 0	D ₀	D ₀	D ₀	...	D ₀	D ₀	D ₀	D ₀
Row 1	D ₁	D ₁	D ₁	...	D ₁	D ₁	D ₁	D ₁
Row 2	D ₂	D ₂	D ₂	...	D ₂	D ₂	D ₂	D ₂
Row 3	D ₃	D ₃	D ₃	...	D ₃	D ₃	D ₃	D ₃
Address	119H	111H	109H	...	19H	11H	09H	01H
Row 4	D ₀	D ₀	D ₀	...	D ₀	D ₀	D ₀	D ₀
Row 5	D ₁	D ₁	D ₁	...	D ₁	D ₁	D ₁	D ₁
Row 6	D ₂	D ₂	D ₂	...	D ₂	D ₂	D ₂	D ₂
Row 7	D ₃	D ₃	D ₃	...	D ₃	D ₃	D ₃	D ₃
Address	11AH	112H	10AH	...	1AH	12H	0AH	02H
Row 8	D ₀	D ₀	D ₀	...	D ₀	D ₀	D ₀	D ₀
Row 9	D ₁	D ₁	D ₁	...	D ₁	D ₁	D ₁	D ₁
Row 10	D ₂	D ₂	D ₂	...	D ₂	D ₂	D ₂	D ₂
Row 11	D ₃	D ₃	D ₃	...	D ₃	D ₃	D ₃	D ₃
Address	11BH	113H	10BH	...	1BH	13H	0BH	03H
Row 12	D ₀	D ₀	D ₀	...	D ₀	D ₀	D ₀	D ₀
Row 13	D ₁	D ₁	D ₁	...	D ₁	D ₁	D ₁	D ₁
Row 14	D ₂	D ₂	D ₂	...	D ₂	D ₂	D ₂	D ₂
Row 15	D ₃	D ₃	D ₃	...	D ₃	D ₃	D ₃	D ₃

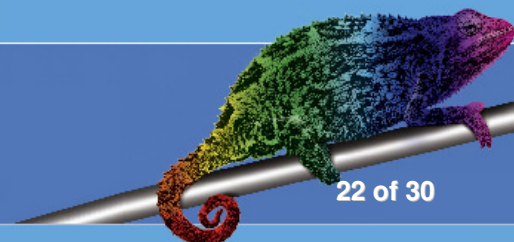

SA3216 – SA3624 – SA6432

Technical Datasheet



Bit/Pixel Mapping Table for SA6432

	Column 63	Column 62	Column 61	Column 60	...	Column 3	Column 2	Column 1	Column 0
Address	1FCH	1F4H	1ECH	1E4H	...	1CH	14H	0CH	04H
Row 16	D ₀	D ₀	D ₀	D ₀	...	D ₀	D ₀	D ₀	D ₀
Row 17	D ₁	D ₁	D ₁	D ₁	...	D ₁	D ₁	D ₁	D ₁
Row 18	D ₂	D ₂	D ₂	D ₂	...	D ₂	D ₂	D ₂	D ₂
Row 19	D ₃	D ₃	D ₃	D ₃	...	D ₃	D ₃	D ₃	D ₃
Address	1FDH	1F5H	1EDH	1E5H	...	1DH	15H	0DH	05H
Row 20	D ₀	D ₀	D ₀	D ₀	...	D ₀	D ₀	D ₀	D ₀
Row 21	D ₁	D ₁	D ₁	D ₁	...	D ₁	D ₁	D ₁	D ₁
Row 22	D ₂	D ₂	D ₂	D ₂	...	D ₂	D ₂	D ₂	D ₂
Row 23	D ₃	D ₃	D ₃	D ₃	...	D ₃	D ₃	D ₃	D ₃
Address	1FEH	1F6H	1EEH	1E6H	...	1EH	16H	0EH	06H
Row 24	D ₀	D ₀	D ₀	D ₀	...	D ₀	D ₀	D ₀	D ₀
Row 25	D ₁	D ₁	D ₁	D ₁	...	D ₁	D ₁	D ₁	D ₁
Row 26	D ₂	D ₂	D ₂	D ₂	...	D ₂	D ₂	D ₂	D ₂
Row 27	D ₃	D ₃	D ₃	D ₃	...	D ₃	D ₃	D ₃	D ₃
Address	1FFH	1F7H	1EFH	1E7H	...	1FH	17H	0FH	07H
Row 28	D ₀	D ₀	D ₀	D ₀	...	D ₀	D ₀	D ₀	D ₀
Row 29	D ₁	D ₁	D ₁	D ₁	...	D ₁	D ₁	D ₁	D ₁
Row 30	D ₂	D ₂	D ₂	D ₂	...	D ₂	D ₂	D ₂	D ₂
Row 31	D ₃	D ₃	D ₃	D ₃	...	D ₃	D ₃	D ₃	D ₃
Address	1F8H	1F0H	1E8H	1E0H	...	18H	10H	08H	00H
Row 0	D ₀	D ₀	D ₀	D ₀	...	D ₀	D ₀	D ₀	D ₀
Row 1	D ₁	D ₁	D ₁	D ₁	...	D ₁	D ₁	D ₁	D ₁
Row 2	D ₂	D ₂	D ₂	D ₂	...	D ₂	D ₂	D ₂	D ₂
Row 3	D ₃	D ₃	D ₃	D ₃	...	D ₃	D ₃	D ₃	D ₃
Address	1F9H	1F1H	1E9H	1E1H	...	19H	11H	09H	01H
Row 4	D ₀	D ₀	D ₀	D ₀	...	D ₀	D ₀	D ₀	D ₀
Row 5	D ₁	D ₁	D ₁	D ₁	...	D ₁	D ₁	D ₁	D ₁
Row 6	D ₂	D ₂	D ₂	D ₂	...	D ₂	D ₂	D ₂	D ₂
Row 7	D ₃	D ₃	D ₃	D ₃	...	D ₃	D ₃	D ₃	D ₃
Address	1FAH	1F2H	1EAH	1E2H	...	1AH	12H	0AH	02H
Row 8	D ₀	D ₀	D ₀	D ₀	...	D ₀	D ₀	D ₀	D ₀
Row 9	D ₁	D ₁	D ₁	D ₁	...	D ₁	D ₁	D ₁	D ₁
Row 10	D ₂	D ₂	D ₂	D ₂	...	D ₂	D ₂	D ₂	D ₂
Row 11	D ₃	D ₃	D ₃	D ₃	...	D ₃	D ₃	D ₃	D ₃
Address	1FBH	1F3H	1EBH	1E3H	...	1BH	13H	0BH	03H
Row 12	D ₀	D ₀	D ₀	D ₀	...	D ₀	D ₀	D ₀	D ₀
Row 13	D ₁	D ₁	D ₁	D ₁	...	D ₁	D ₁	D ₁	D ₁
Row 14	D ₂	D ₂	D ₂	D ₂	...	D ₂	D ₂	D ₂	D ₂
Row 15	D ₃	D ₃	D ₃	D ₃	...	D ₃	D ₃	D ₃	D ₃

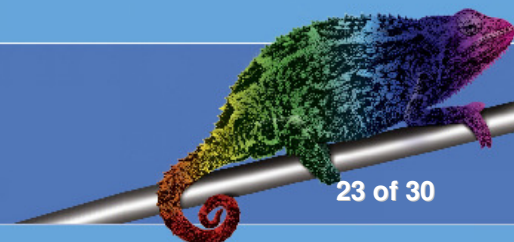

SA3216 – SA3624 – SA6432



























































Technical Datasheet



COLOR TABLE

The color command 01000001 (0x41) initiates the color settings of the SA keyswitches with two bits for the color intensity setting of each color.

The color approximations for SA3216, SA3624 & SA6432 keys are shown in following color table. This table is intended for illustration purposes only. The actual display colors on the LCD display with LED backlighting may be different.

	000000		010000		100000		110000
	000001		010001		100001		110001
	000010		010010		100010		110010
	000011		010011		100011		110011
	000100		010100		100100		110100
	000101		010101		100101		110101
	000110		010110		100110		110110
	000111		010111		100111		110111
	001000		011000		101000		111000
	001001		011001		101001		111001
	001010		011010		101010		111010
	001011		011011		101011		111011
	001100		011100		101100		111100
	001101		011101		101101		111101
	001110		011110		101110		111110
	001111		011111		101111		111111

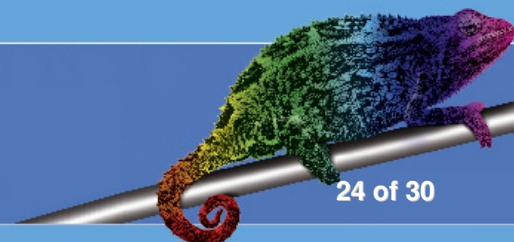

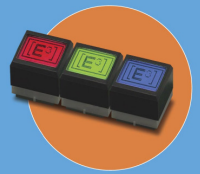

Controlling SA Switch Arrays

Below are sample schematics for controlling one or sixteen SA keyswitches in an array using a PIC16F62X controller to illustrate the simplicity of the control circuitry. Further descriptions including sources are available under the **Application Notes** at our website at www.e3-keys.com.

For additional technical support with your own design implementation, please contact your local [E³] distributor or [E³] at techsupport@e3-keys.com.

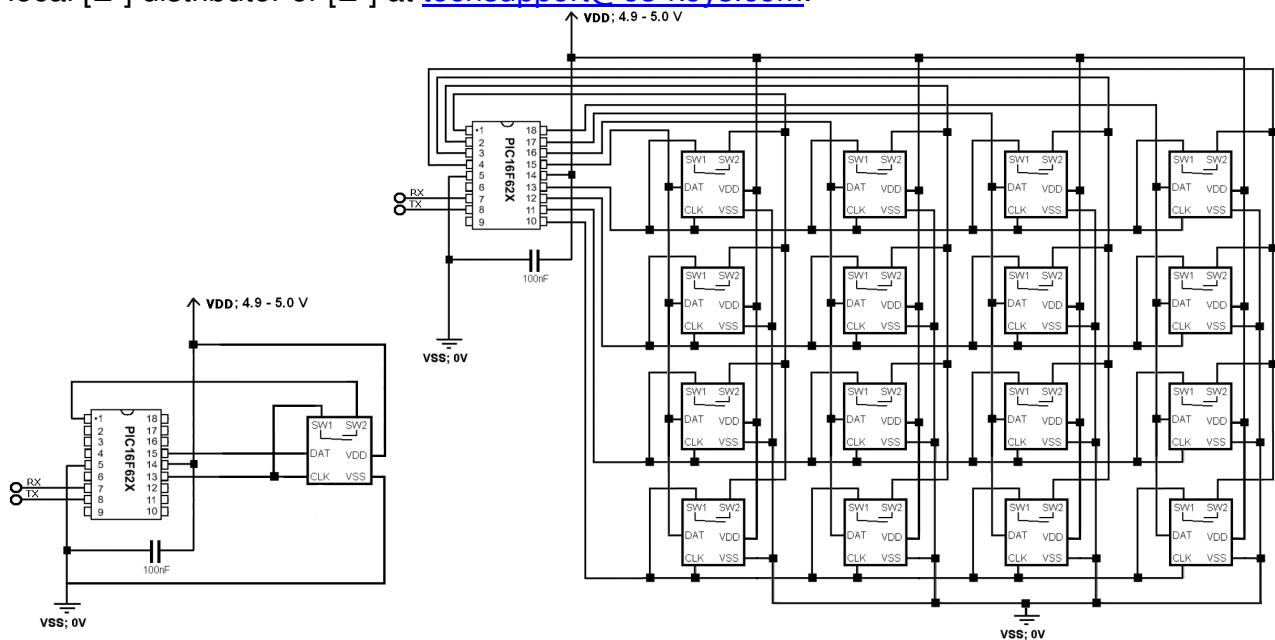

In the above examples the clock and data signals are generated on the corresponding I/O pins of the PIC controller.

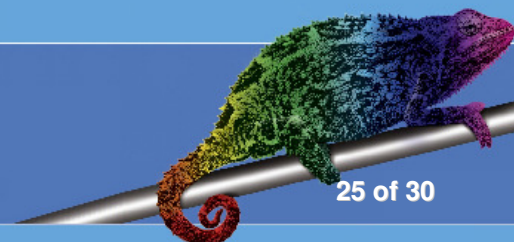

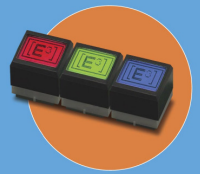

Order Information

Part Number	Description
SA3216-B	SA pushbutton keyswitch with 32x16 pixel display Backlit in 64 RGB colors Black housing (RAL 9005)
SA3624-B	SA pushbutton keyswitch with 36 x 24 pixel display Backlit in 64 RGB colors Black housing (RAL 9005)
SA6432-B	SA pushbutton keyswitch with 64 x 32 pixel display Backlit in 64 RGB colors Black housing (RAL 9005)
SP0000	Socket pin set for use with the SAxxxx switches
DS0000	DemoBoard for use with 2 SAxxxx keys with RS232 interface Keys are not included. Full documentation and software available at www.e3-keys.com .

Other housing colors available on request

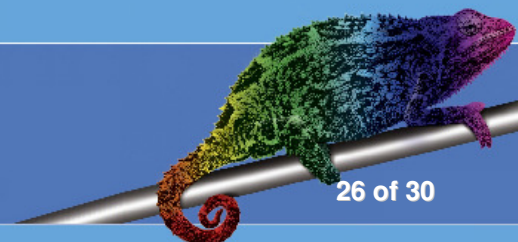

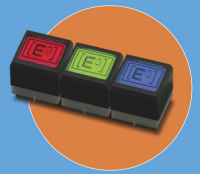

Change History

Version	Date	Comments
0.1	10/06/03	Initial draft document
0.2	11/13/03	Updated draft document
0.3	11/14/03	Final draft document
1.0	11/19/03	Technical Datasheet v1.0
1.1	02/25/04	Correction of typographical errors Tactile force curve illustration updated Layout illustration updated Supply voltage 4.9 to 5.1 V Bit/Pixel Mapping Table for SA6432 changed Bit/Pixel Mapping Table for SA3624 changed Clock phase corrected compatibility reasons to Legacy <i>Legacy Mode™</i> and <i>Advanced Technology™</i> Mode protocols updated Application Notes reference added Table page references added Change History added
1.2	04/07/04	Clock rise and fall time corrected Page 21 color command is 0x41 not 0x42 Comment to command 0x43 added
2.0	01/27/06	Technical update v2.0 Life support application notice added Flammability ratings added

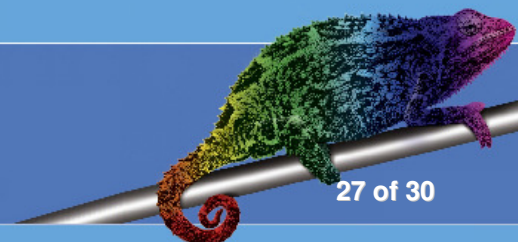

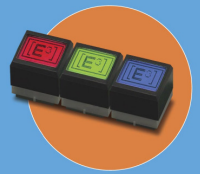

Notices

Copyright Notice

© 2003–2006 Copyright [E³] Engstler Elektronik Entwicklung GmbH. All rights reserved.

[E³], *The Third Evolution*[™] and *Legacy Mode*[™] are trademarks of [E³]. *The Keys to Intelligence*[™] is a trademark of I/O Universal Technologies, Inc. used with permission. All other trademarks are property of their respective owners.

No part of this publication may be copied, photocopied, reproduced, translated or reduced to any electronic medium or machine-readable form without the expressed written consent of [E³] Engstler Elektronik Entwicklung GmbH.

Technical Notices

This datasheet is intended for technically qualified personnel trained in the field of electronics.

The knowledge of electronics and the technically correct implementation of the content of this datasheet are required for problem free installation, implementation and safe operation of the described product. Only qualified personnel have the required know-how to implement the specifications given in this data sheet.

For clarity, not all details regarding the product or its implementation, installation, operation, or maintenance have been included. Should you require additional information or further assistance, please contact your local [E³] distributor or [E³] Engstler Elektronik Entwicklung GmbH at techsupport@e3-keys.com. You may also visit our website at www.e3-keys.com.

Life Support Applications

The products discussed in this document are not designed for use in life support appliances, devices, or systems where malfunction of these products can reasonably be expected to result in personal injury. [E³] customers using or selling these products for use in such applications do so at their own risk and agree to fully indemnify [E³] for any damages resulting from such improper use or sale.

Flammability Ratings

The SAxxxx base is rated UL94-V0; all other plastics are rated UL94-HB.

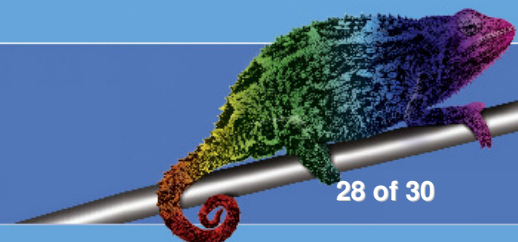

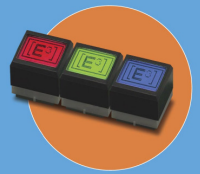

Warranty Disclaimer

[E³] ENGSTLER ELEKTRONIK ENTWICKLUNG GMBH grants no warranty with respect to this data sheet, neither explicit nor implied, and it is not liable for direct or indirect damages. Some states do not grant the exclusion of incidental or consequential damages and, therefore, this statement may not be valid in such cases.

This data sheet has been produced with all due care. However, since errors cannot be excluded, [E³] Engstler Elektronik Entwicklung GmbH does not grant any warranty or accept any legal responsibility or liability in any form for erroneous statements herein.

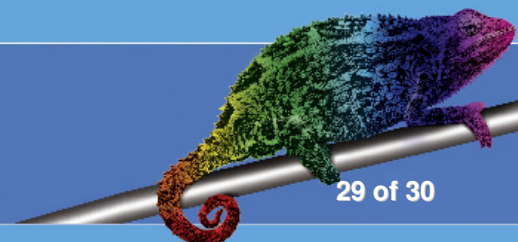

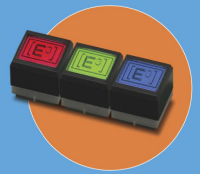

Contact Information

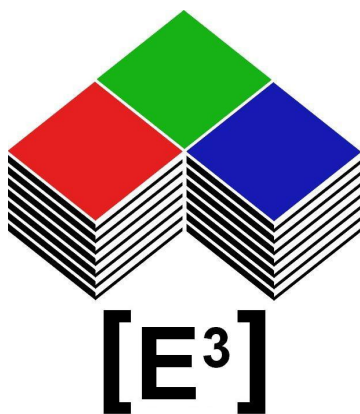

[E³]
Engstler
Elektronik
Entwicklung
GmbH

Industriering 7
63868 Grosswallstadt
Germany

Phone: +49 (0) 6022 262570
Fax: +49 (0) 6022 262571
E-Mail: info@e3-keys.com

